

Coupling Motion by Mean Curvature and Motion by Surface Diffusion

Amy Novick-Cohen¹

Arcady Vilenkin², Olga Smirin-Zelekman¹,
Anna Seligman¹, Vadim Derkach¹

¹Department of Mathematics, Technion–IIT, Haifa, Israel

²Department of Physics, Hebrew University, Jerusalem, Israel

The coupled motion as a sharp interface limit

Coupled motion by mean curvature and surface diffusion can be obtained in a sharp interface limit, from the **Allen-Cahn/Cahn-Hilliard system**:

$$u_t = 4\epsilon^2 \nabla \cdot Q(u, v) \nabla \frac{\delta \mathcal{F}}{\delta u}, \quad v_t = -\frac{1}{4} Q(u, v) \frac{\delta \mathcal{F}}{\delta v},$$

where

$$\mathcal{F} = \int_{\Omega} \left\{ F(u, v) + \frac{1}{2} \epsilon^2 \{ |\nabla u|^2 + |\nabla v|^2 \} \right\} dx,$$

and

$$F(u, v) = \frac{\Theta}{2} (G(u+v) + G(u-v)) + \alpha u(1-u) - \beta v^2,$$

$$G(s) = s \ln s + (1-s) \ln(1-s), \quad Q(u, v) = u(1-u)(1/4 - v^2),$$

which was proposed as a diffuse interface model for simultaneous order-disorder and phase separation (J.W. Cahn & A. N.-C, 1994, Eguchi & Ninomiya, 1988), to describe Krzanowski instabilities (Krzanowski & Allen, 1986) in which droplets of a minor disordered phase coagulate along a slowly curved boundary separating two ordered phases.

Under appropriate scaling assumptions:

At intersections of IPB's with $d\Omega$

- 1) $\mathbf{n} \cdot \frac{\mathbf{n}}{d\Omega} = 0$
- 2) $\mathbf{n} \cdot \nabla_s H^{-1/2} = 0$
- 3) Isolated interfaces do not detach

At intersection of APB's with $d\Omega$

- 1) $\mathbf{n} \cdot \frac{\mathbf{n}}{d\Omega} = 0$
- 2) $\mathbf{n} \cdot \nabla_s \mu^{1/2} = 0$
- 3) Isolated interfaces do not detach

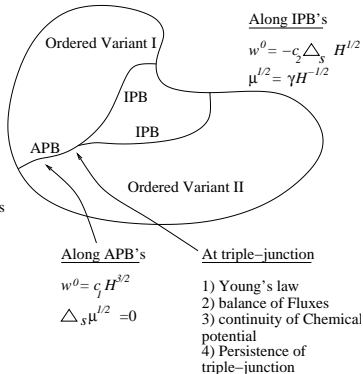

Figure 1: The limiting motion.

The coupled motion in the context of grain boundaries

The coupled motion also occurs naturally in the context of **sintering**, in which small metal particles coalesce, typically under pressure, to form a block of solid material, (M. Ashby, 1974, W. Zhang, et. al., 1994). In this case, the exterior of the particles evolve by surface diffusion, and the boundary between two particles evolves by motion by mean curvature.

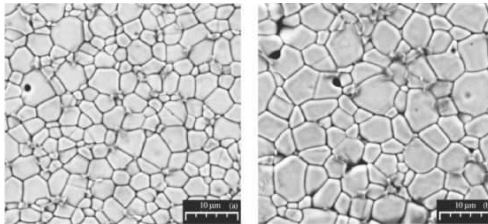

Figure 2: Sketch of grains and grain boundaries after sintering.

Grain, Grain Boundaries and Polycrystalline Materials. Thin Films

- A **grain** is a solid composed of atoms on a **crystalline lattice**.
- The crystalline lattice of a given grain is **oriented spatially**.
- **Grain boundaries** are interfaces where different grains meet.
- **Polycrystalline materials** are solids composed of a large number of crystals of varying size and orientation.
- At sufficiently high temperatures, grain boundaries migrate to reduce surface free energy.

W.W. Mullins in 1957 considered the motion of the **thermal grooves** which can be seen to appear on the exterior surface of polycrystalline specimens, and formulated equations for their motion under the influence of **surface diffusion**. W.W. Mullins had in 1956 considered the motion of grain boundaries within polycrystalline specimens under the influence of **motion by mean curvature**.

Features of interest

Various physical phenomena connected to grain boundary migration which influence film stability and robustness.

- Thermal grooving.
- Pitting at quadruple junctions.
- Jerky motion.

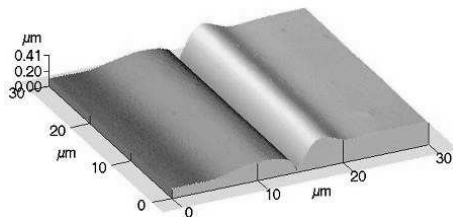

(a)

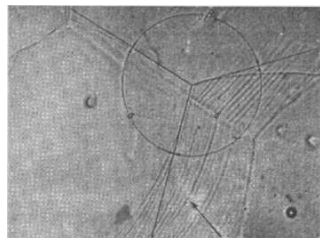

(b)

Figure 3: (a) Grooving (Rabkin, Mullins). (b) Jerky motion (Mullins).

A Problem Formulation

We focus on the coupled motion of grain boundaries with external surfaces, neglecting elasticity, anisotropy, evaporation/condensation, defects. Following Mullins, 1957

Basic assumptions (Kanel, N.-C., & Vilenkin, 2003)

- Grain boundaries evolve by motion by mean curvature.
- Exterior surfaces evolve by surface diffusion.
- Conditions along thermal grooves:
 - A persistence condition.
 - Balance of mechanical forces.
 - Continuity of the chemical potential.
 - Balance of mass flux.

Based on the above problem formulation, it is possible to consider the existence of traveling wave solutions.

Traveling wave solutions

Let $\Psi(s)$ be the angle between the exterior surface and the grain boundary, and let s be an arc-length parametrization of a traveling wave profile, as in Figure 3(a). Then $\Psi(s)$ should satisfy:

$$(\mathbf{P}_\Psi) \quad \begin{cases} \Psi_{sss} = \sin \Psi, & s \in (-\infty, 0) \cup (0, \infty), \\ \Psi(0^+) = \Psi(0^-) + 2 \arcsin(m/2), \\ \Psi_s(0^+) = \Psi_s(0^-), \\ \Psi_{ss}(0^+) = \Psi_{ss}(0^-), \\ \Psi(\pm\infty) = 0. \end{cases}$$

where $m = \frac{\gamma_{\text{grain boundary}}}{\gamma_{\text{exterior surface}}}$ is the ratio of the surface energies.

Theorem

For any $0 \leq m < 2$, there exists a solution to (\mathbf{P}_Ψ) .

(Kanel, N.-C. & Vilenkin, 2004, Also Cahn & Penrose, 2003).

Grain Boundary Motion in Thin Films: A Radial Symmetric Case

Amy Novick-Cohen, Arkady Vilenkin,
Olga Zelekman-Smirin,

Dept. of Physics, Hebrew University, Jerusalem, Israel

Dept. of Mathematics, Technion-IIT, Haifa, Israel,

The Initial Geometry

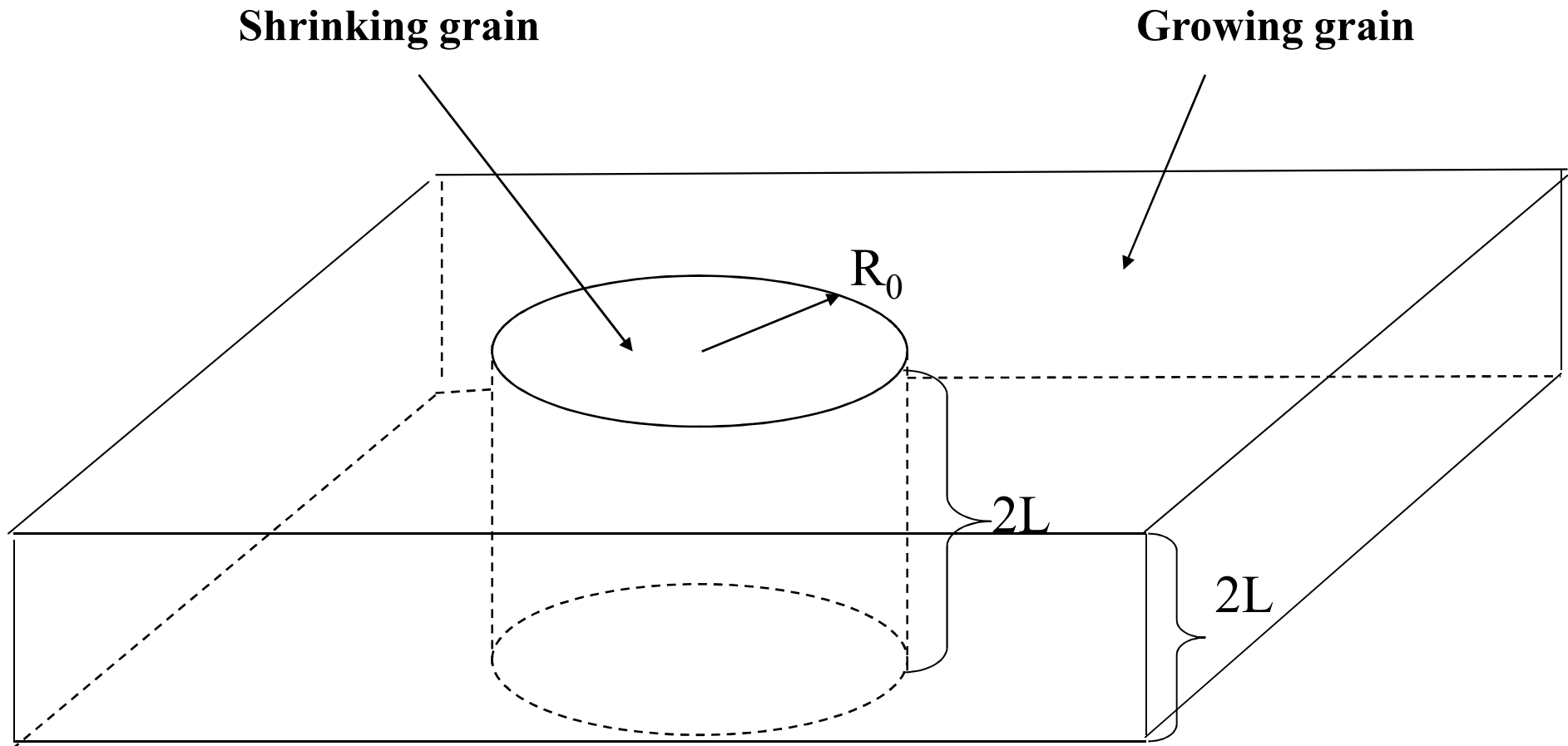

The Governing Equations

On the grain boundary:

Motion by mean curvature: $V_n = A k$

On the exterior surface:

Motion by surface diffusion: $V_n = B \Delta_s k$

Along the thermal groove:

Young's law (balance of mechanical forces)

Continuity of chemical potential

Balance of flux

The Problem Parameters and Variables

Physical parameters:

$$A, [A]=X^2/T, \quad B, [B]=X^4/T, \quad \gamma_{gb}, [\gamma_{gb}]=M/T^2, \quad \gamma_{ext\ surf}, [\gamma_{ext\ surf}]=M/T^2$$

Geometric parameters:

$$R_0, [R_0]=X, \quad L, [L]=X$$

Length and time scales:

$$\bar{T} = B/A^2, \quad \bar{X} = \sqrt{B/A}$$

Dimensionless parameters:

$$m \left(= \frac{\gamma_{gb}}{\gamma_{ext\ surf}} \right), \quad R_0 \left(= \frac{R_0}{\bar{X}} \right), \quad L \left(= \frac{L}{\bar{X}} \right)$$

The mean curvature along the grain boundary

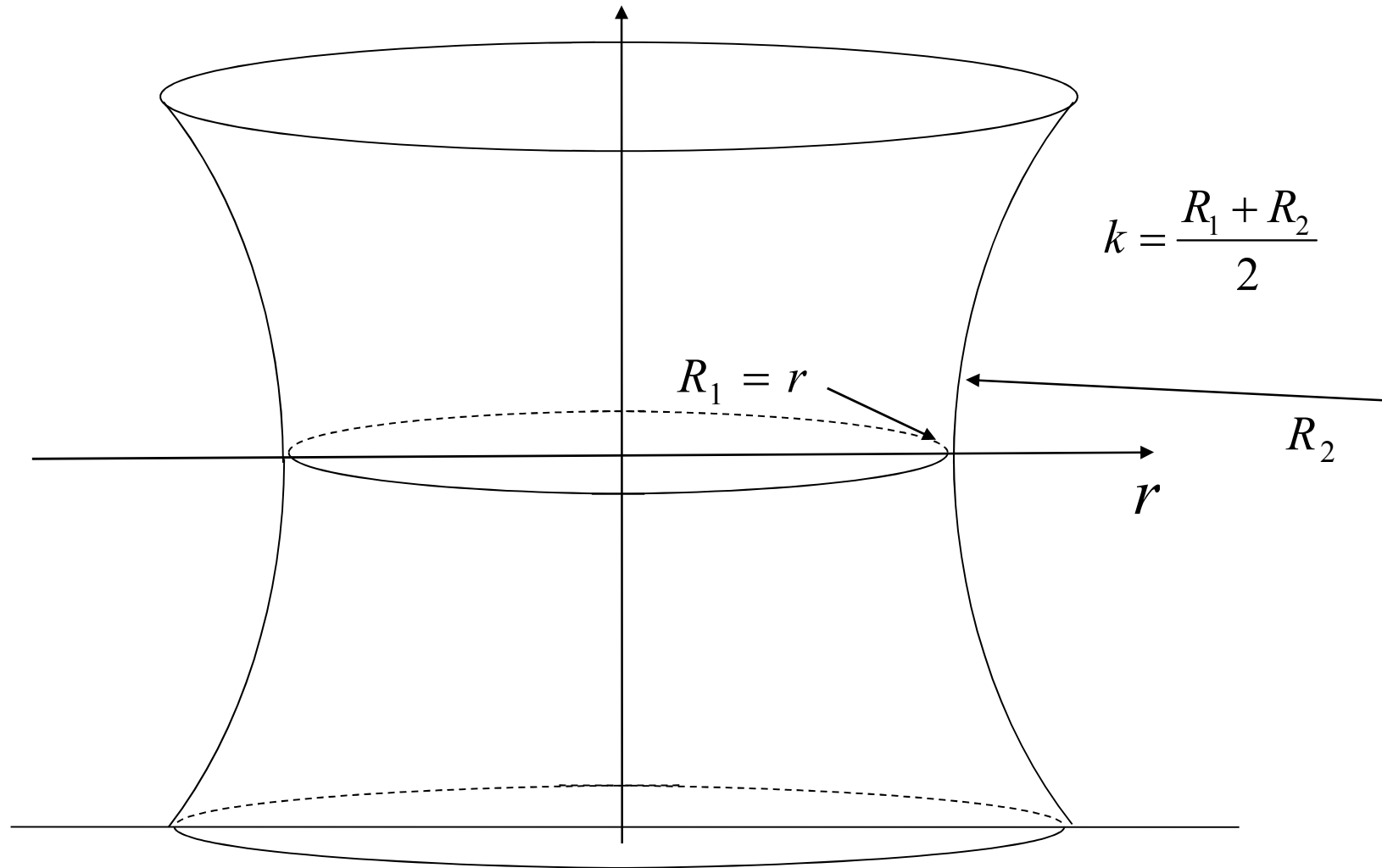

Definition of variables in the central cross section

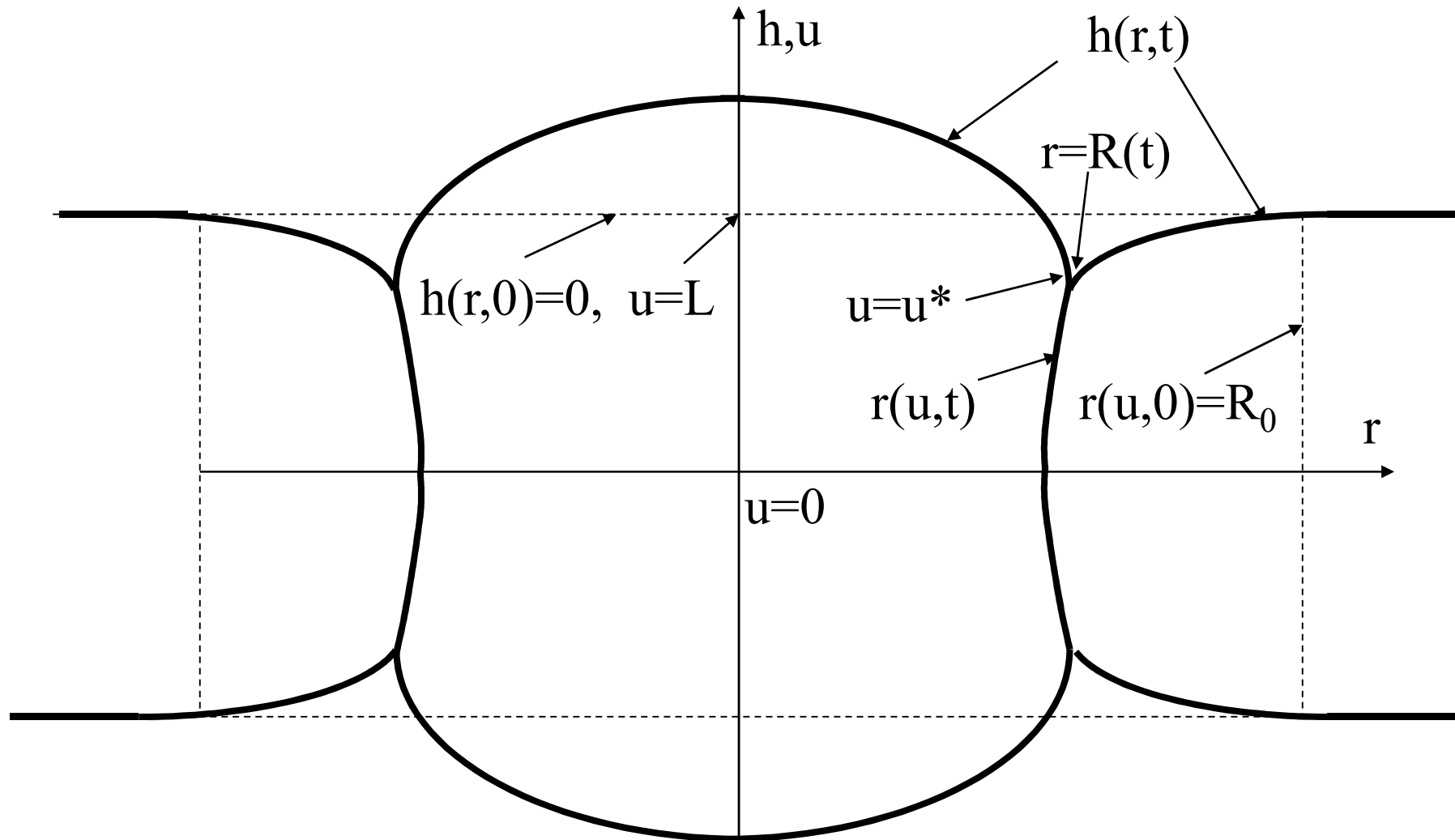

The Mathematical Problem Formulation

$$\begin{aligned}
 h_t &= -B\left(\frac{k_r}{\sqrt{1+h_r^2}}\right)_r, \quad 0 < r < \infty, r \neq R(t), & h_r(0,t) &= 0, \quad k_r(0,t) = 0, \\
 k &= r^{-1}(rh_r(1+h_r^2)^{-1/2})_r, & r_u(0,t) &= 0, \\
 r_t &= A\left(\frac{r_{uu}}{1+r_u^2} - \frac{1}{r}\right), \quad 0 < u < u^*, & h(\infty,t) &= h_r(\infty,t) = 0, \\
 u^* &= L + h(R(t),t). & r(u,0) &= R_0, \quad 0 < u < L, \quad t = 0, \\
 & & h(r,0) &= 0, \quad 0 < r < \infty, \quad t = 0.
 \end{aligned}$$

Boundary conditions along the groove root:

$$\begin{aligned}
 r(L + h(R(t), t), t) &= R(t), & h(R(t) - 0, t) &= h(R(t) + 0, t), \\
 k(R(t) - 0, t) &= k(R(t) + 0, t), & \arctan h_r(R(t) + 0, t) - \\
 \frac{k_r}{\sqrt{1+h_r^2}} \Big|_{r=R(t)-0} &= \frac{k_r}{\sqrt{1+h_r^2}} \Big|_{r=R(t)+0}, & \arctan h_r(R(t) - 0, t) &= 2 \arcsin(m/2), \\
 & & \arctan h_r(R + 0, t) + \arctan h_r(R - 0, t) &= \\
 & & & \pi + 2 \arctan r_u^{-1}(L + h(R, t), t),
 \end{aligned}$$

An Annihilation-Break Up Transition

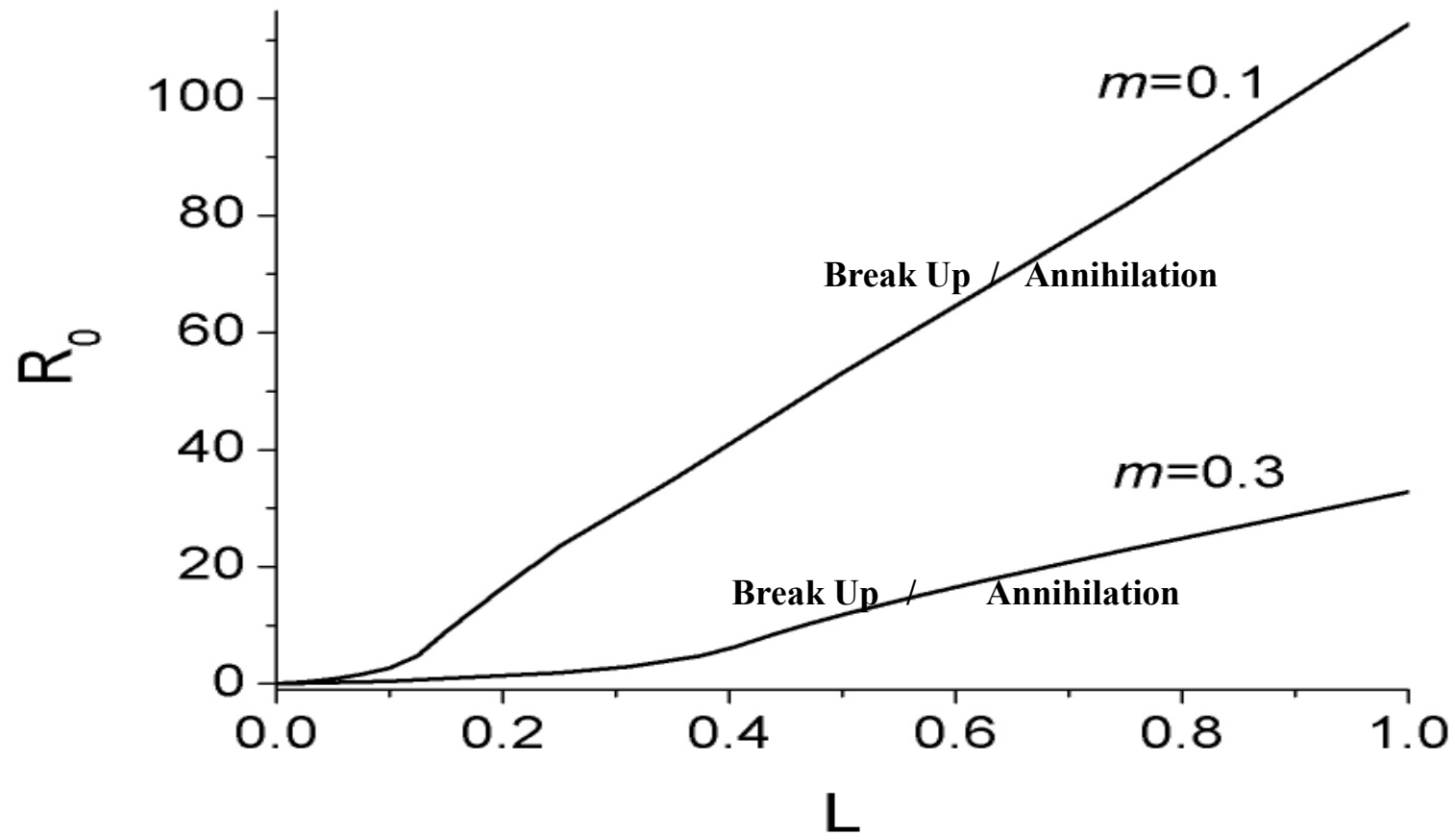

The Grain Radius $R(t)$ as a Function of Time.

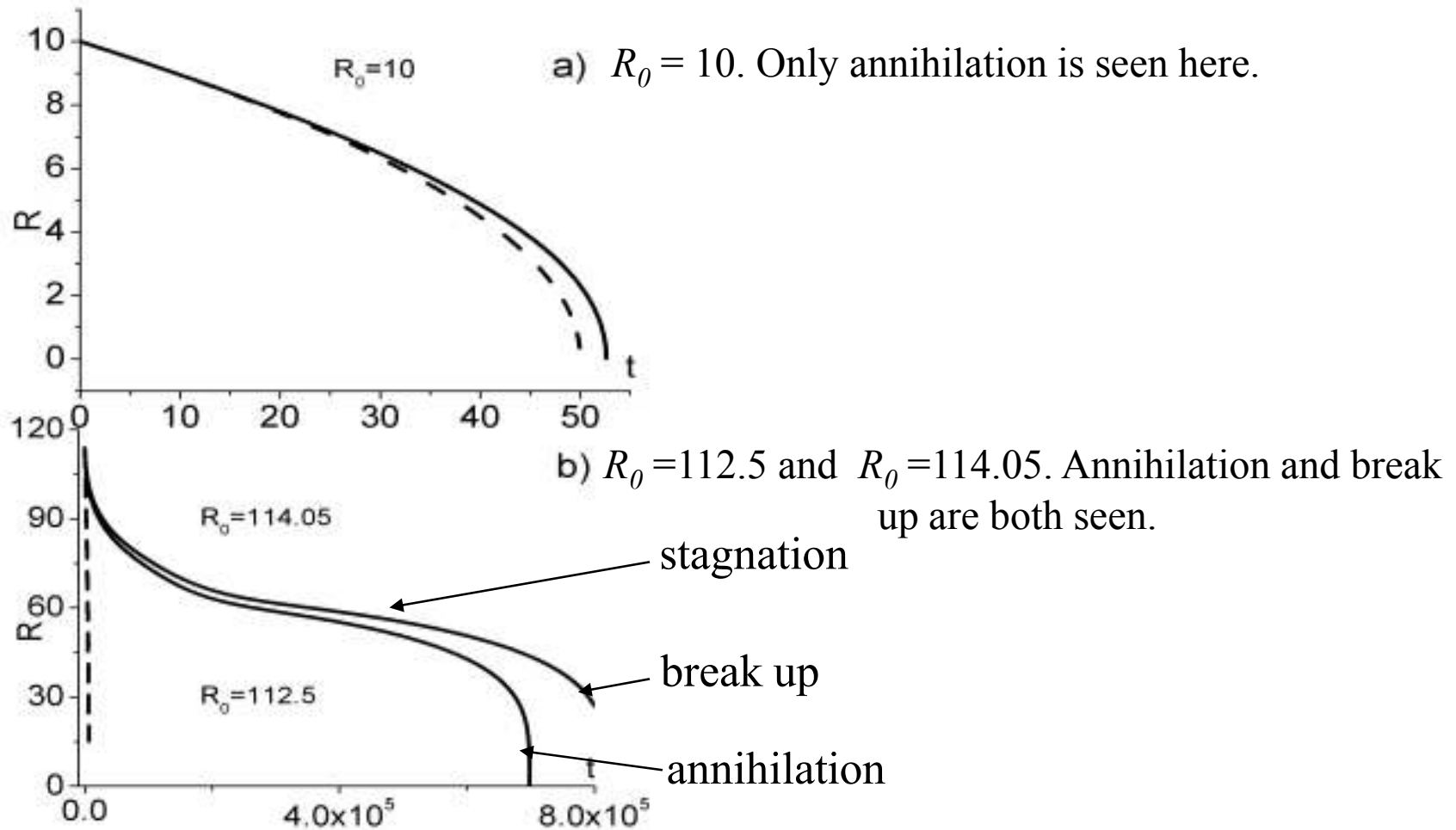

In (a) and (b), $m=0.1$, $L=1$. The dashes lines indicate $R(t)$ for $m=0$.
The annihilation-break up transition occurs at $R(t)=112.7$.

Depth of the Groove as a Function of Time

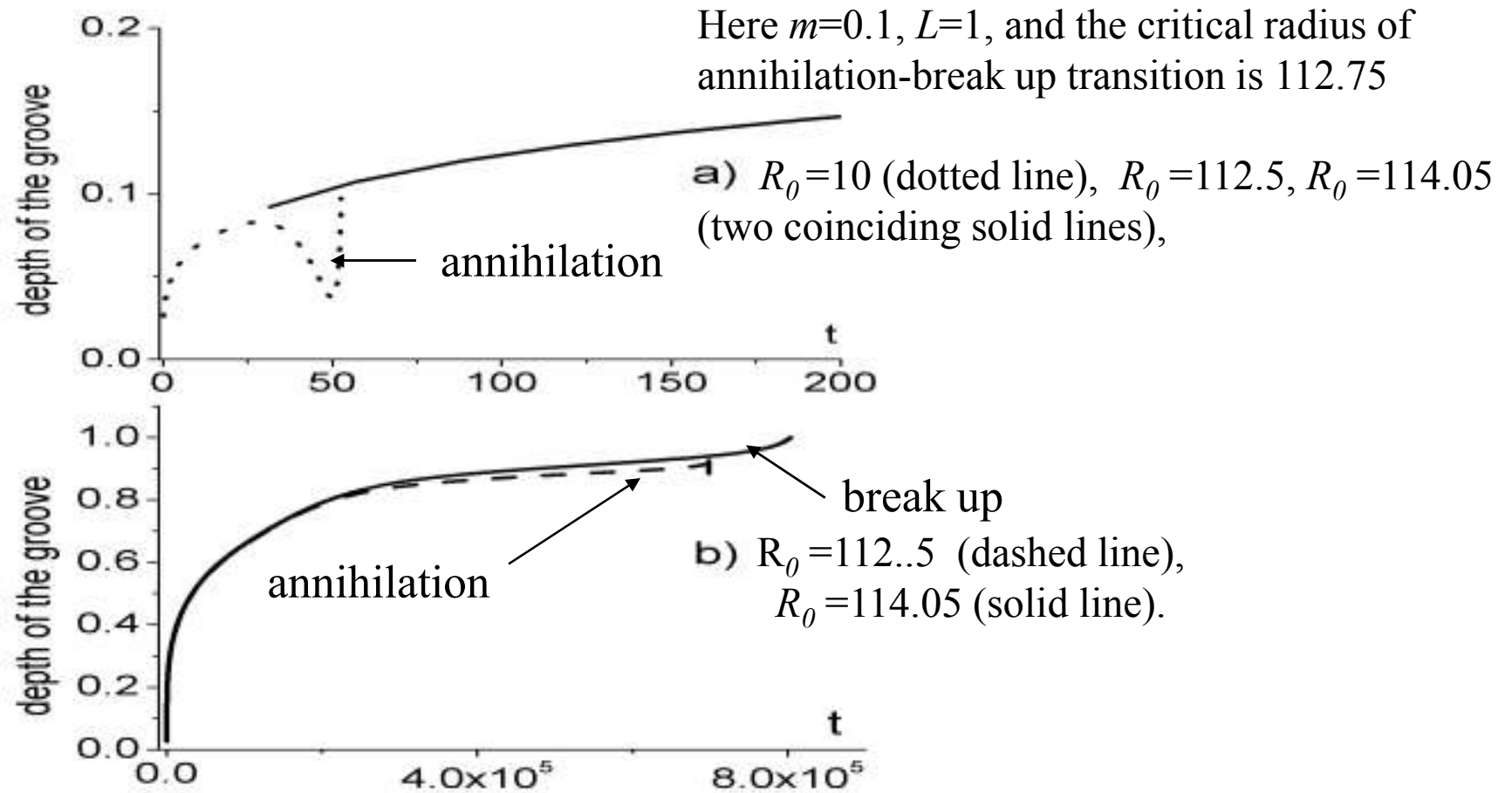

Shape of Grain Boundary during Break up

Here $m=0.1$, $L=1$, $R_0=114.05$.

The critical radius for the annihilation-break up transition here is 112.75

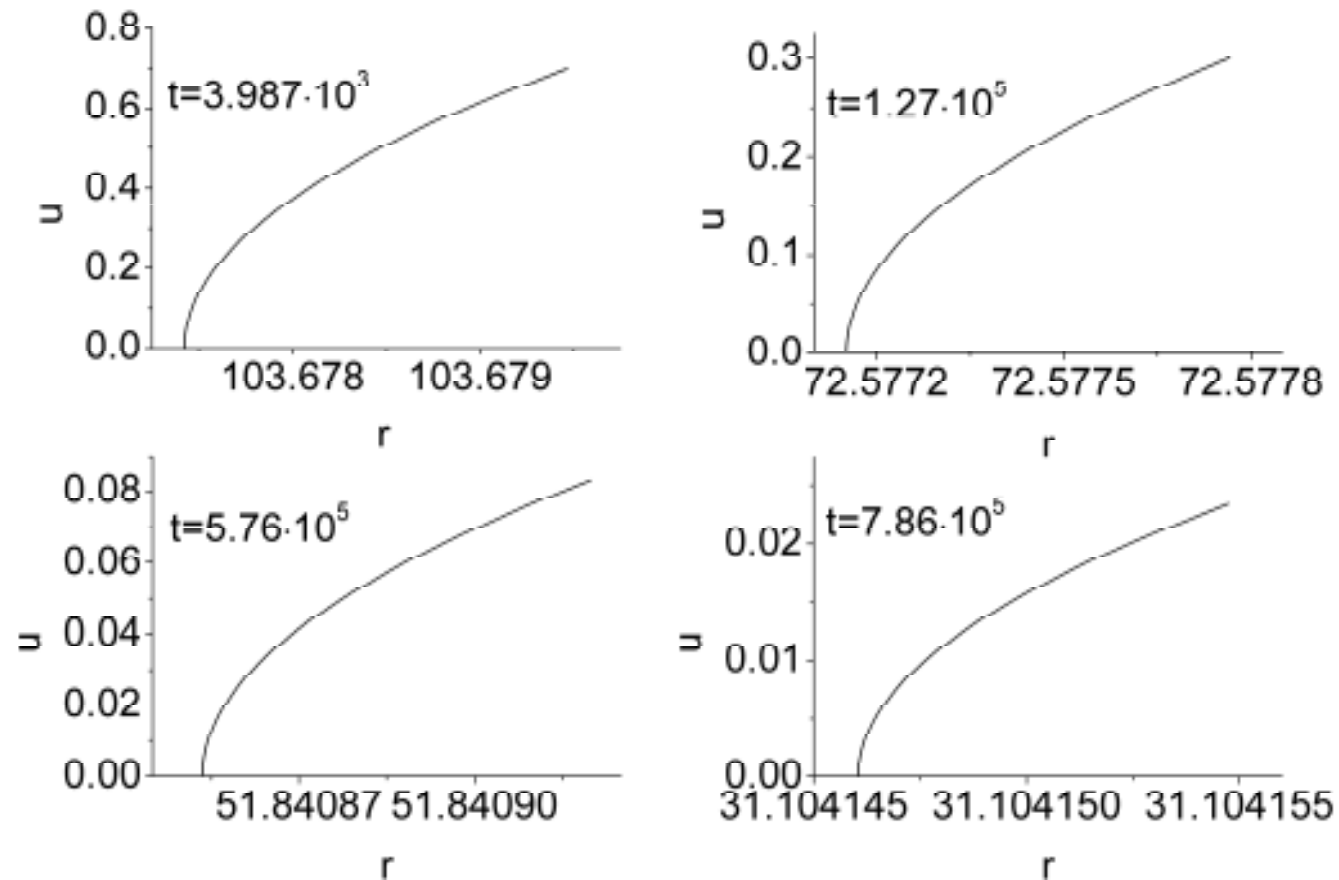

Speed of grain boundary motion

Motion of grain boundary when $m=0$: $R_t = -1/R$

Motion seen in calculations for $0 < m \ll 1$:

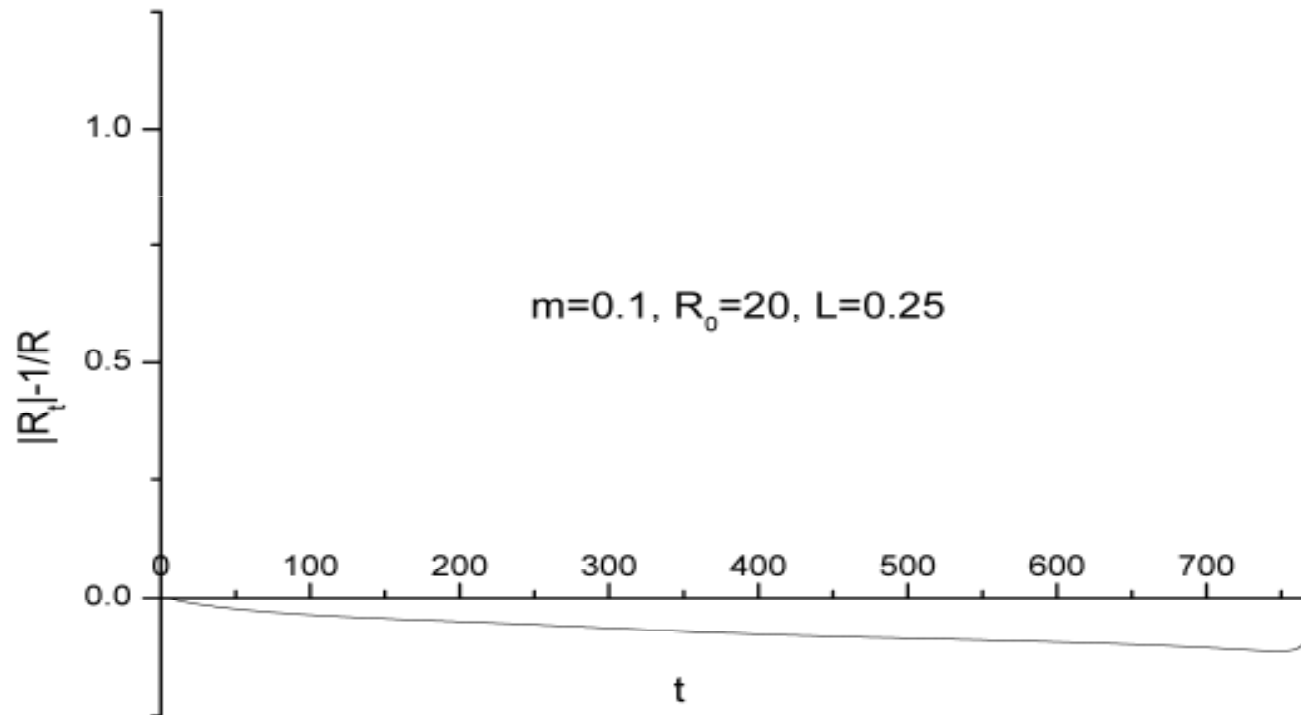

Shape of grain boundary

Grain boundary when $m=0$: flat

Grain boundary when $0 < m \ll 1$: parabolic

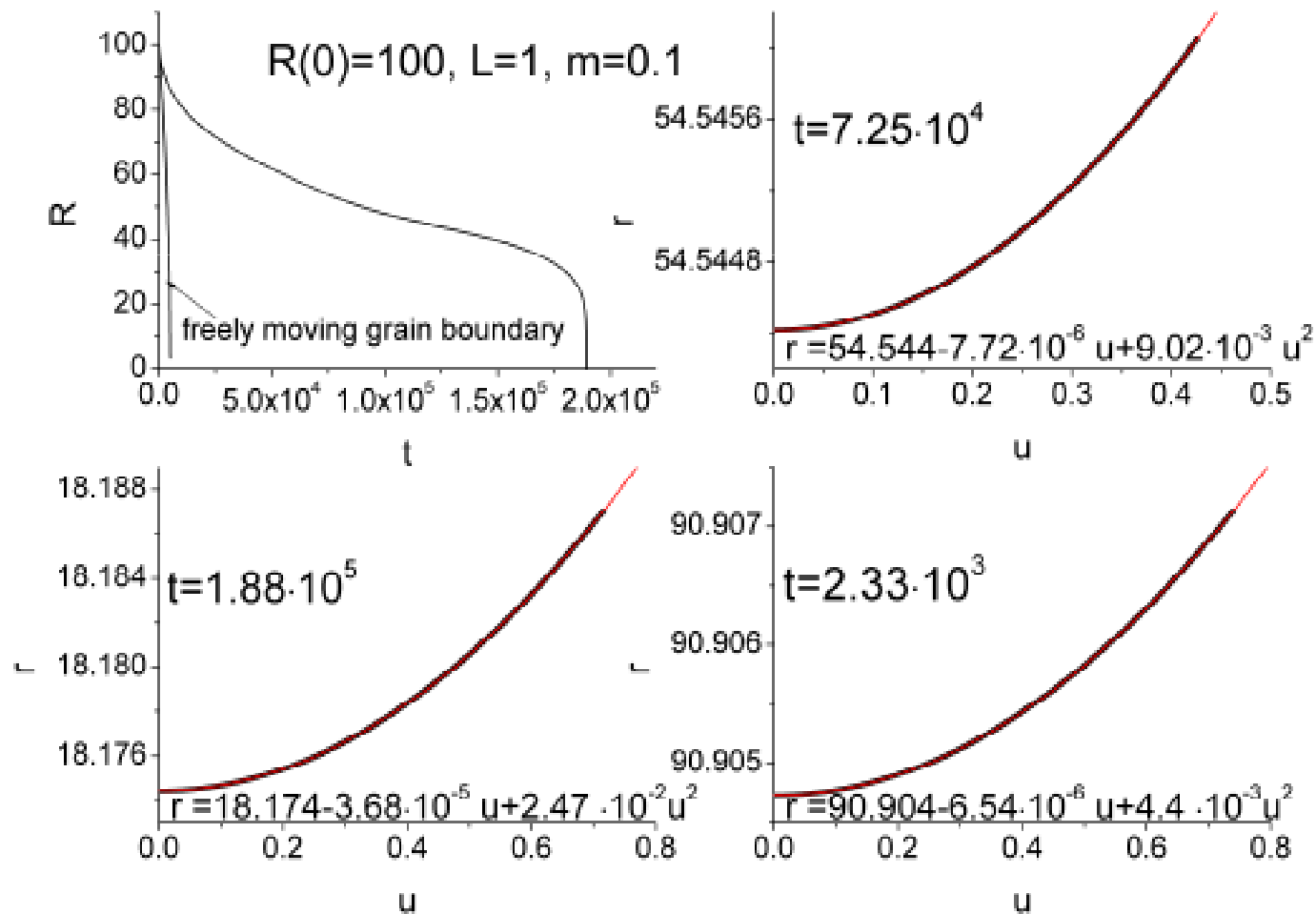

A bit of asymptotic analysis

Reformulate problem onto a fixed interval taking into account the structure of the solution:

$$h(r, t) = R(t)H(p, t) \Big|_{p=r/R(t)}$$

$$r(u, t) = R(t) + \tan \theta u^*(t) \rho(s, t) \Big|_{s=u/u^*(t)}$$

$$\rho(s, t) = \bar{\rho}(t) + (1/2)(s^2 - 1/3) + g(s, t),$$

shaped by the functions:

$$R(t), u^*(t), \theta(t), \bar{\rho}(t) \left(:= \int_0^1 \rho(s, t) ds \right).$$

A distinguished scaling limit

Focus on a distinguished scaling limit : $0 < m = L / R_0 \ll 1$,

Expand the functions: $H(p, t)$, $g(s, t)$,
in powers of m

To leading order, we get a coupled system for the evolution of the exterior surface:

$$H_t = \dots, \quad R_t = \dots, \quad g \approx 0.$$

Implications of the Asymptotics

The equation: $g \approx 0$ implies that to leading order the grain boundary profile is parabolic:

$$\rho(s, t) = \bar{\rho}(t) + (1/2)(s^2 - 1/3),$$

and for the motion of the thermal groove we get:

$$R_t = \left[\frac{\theta(t)}{u^*(t)} - \frac{1}{R} \right].$$

Two limits

A) If $0 < m, L / R_0 \ll 1, mL / R_0 = O(1)$, then the groove root is quasi-stationary, and pinch-off ensues.

B) If $0 < m, L / R_0 \ll 1, mL / R_0 = o(1)$, then $\theta(t) / u^*(t) \approx 1 / 6R_0 = m / 6L$, and annihilation ensues with the prediction:

$$R_t = \left[\frac{m}{6L} - \frac{1}{R} \right].$$

Further verification of law of motion

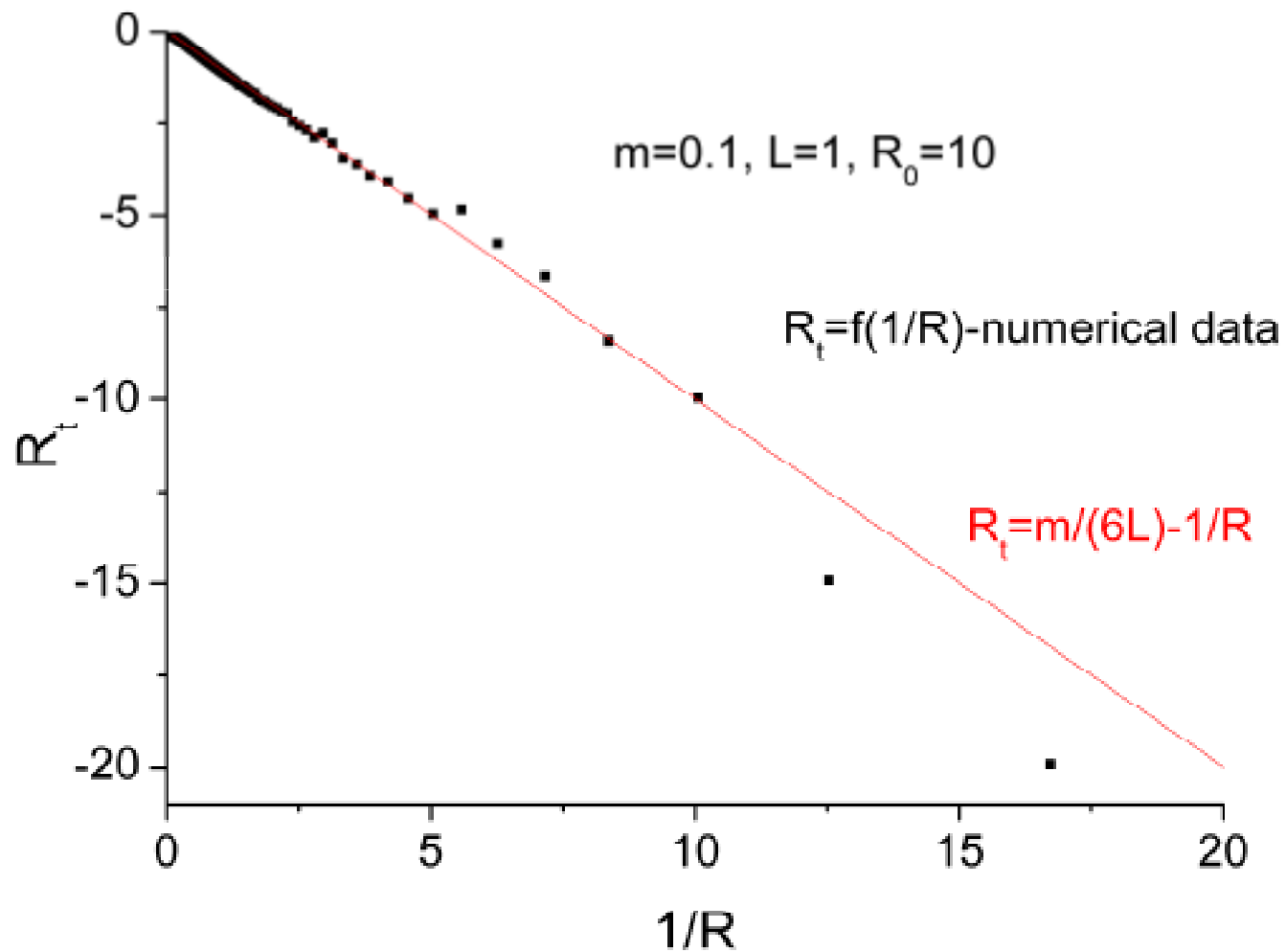

The influence of surface evolution on mobility measurements

A. Rotman, A. Novick-Cohen, A. Vilenkin

Department of Mathematics, Technion–IIT, Haifa, Israel,

Department of Physics, Hebrew University, Jerusalem, Israel.

The basic assumptions

We analyze the coupled motion of a *grain boundary* attached at a *groove root* to an exterior surface in a *half-loop geometry* in *thin samples*.

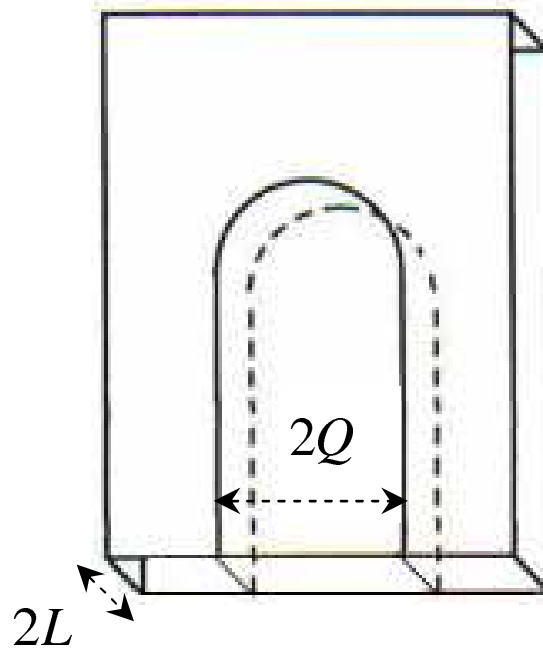

Figure 1: The *half-loop geometry*.

The equations

We assume that the grain boundary evolves according to **motion by mean curvature**,

$$(1) \quad V = A\kappa,$$

and the exterior surface evolves by **surface diffusion**

$$(2) \quad V = -B\Delta_s\kappa,$$

where V is the **normal velocity**, κ is the **mean curvature** and Δ_s is the Laplace-Beltrami operator.

Boundary conditions

Assuming **mechanical equilibrium** along the triple line (Herring [3]):

$$(3) \quad \sum_{j=I}^{III} \left(\gamma^j \tau^j + \frac{\partial \gamma^j}{\partial \mathbf{n}_j} \right) = 0.$$

In the isotropic case, γ is independent of orientation, and as the two grains comprising the bicrystal are identical, $\gamma^I = \gamma^{II}$. Hence, setting $m := \frac{\gamma^{III}}{\gamma^I}$,

$$(4) \quad \tau^I + \tau^{II} + m\tau^{III} = 0.$$

The **persistence condition** states that surfaces remain attached

$$(5) \quad X^I = X^{II} = X^{III}.$$

From a sketch, it is clearer..

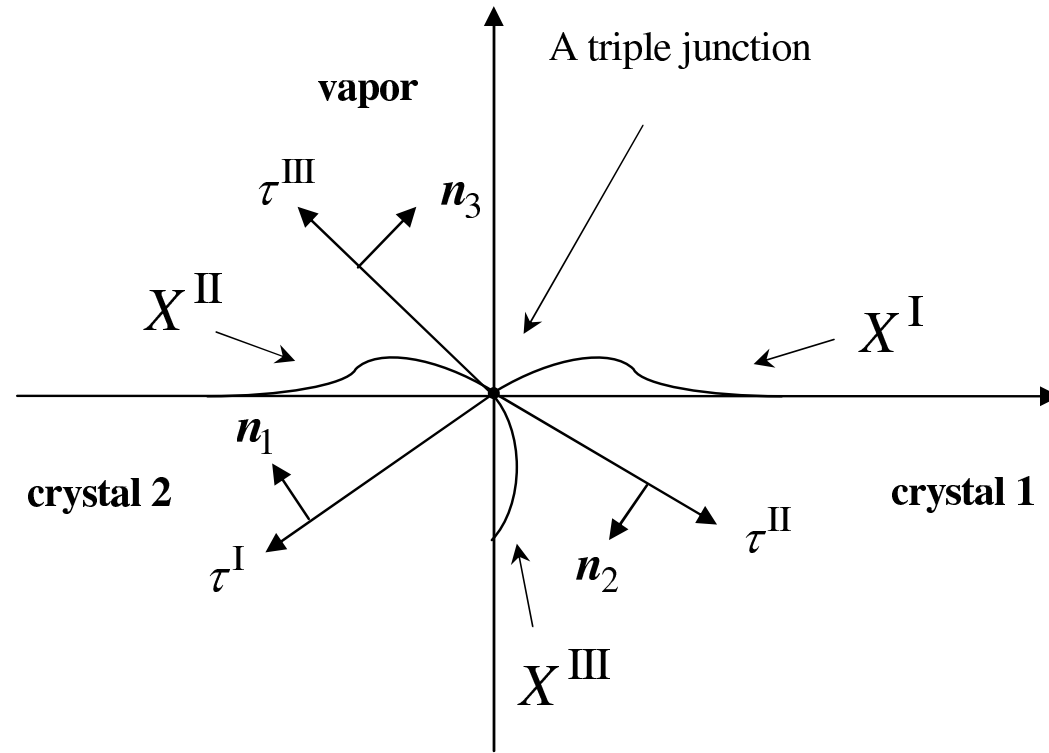

Figure 2: Cross-sectional view of a triple junction.

More boundary conditions

Continuity of the surface chemical potentials may be expressed as

$$(6) \quad \mu^I = \mu^{II},$$

where μ^I, μ^{II} are the chemical potentials of X^I, X^{II} . In the isotropic case, $\mu^i \propto \kappa^i$,
so

$$(7) \quad \kappa^I = \kappa^{II}.$$

Balance of the mass flux along the triple junction line may be written as

$$(8) \quad \langle \tau^I, \vec{J}^I \rangle + \langle \tau^{II}, \vec{J}^{II} \rangle = 0.$$

Setting $\vec{J} = c \nabla_s \kappa$, where c is a physical constant,

$$(9) \quad \langle \tau^I, \nabla_s \kappa^I \rangle + \langle \tau^{II}, \nabla_s \kappa^{II} \rangle = 0.$$

Dimensionless formulation

We assume $0 < m \ll 1$. We use L and Q to scale length in z -direction and in xy -plane, respectively, and $\frac{Q^2}{A}$ to scale time.

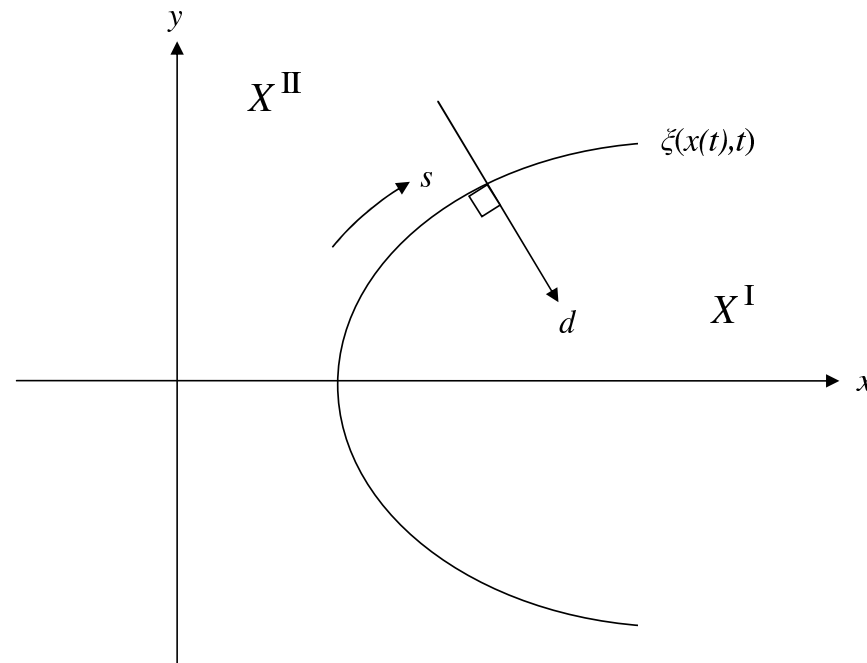

Figure 3: View from above, the coordinates (d, s) .

Parametrization of our surfaces

We assume the following parametrization of our three surfaces

$$(10) \quad X^{\text{I}}(d, s, t) = (\varphi^{\text{I}}(d, s, t), \psi^{\text{I}}(d, s, t), h^{\text{I}}(d, s, t)),$$

$$(11) \quad X^{\text{II}}(d, s, t) = (\varphi^{\text{II}}(d, s, t), \psi^{\text{II}}(d, s, t), h^{\text{II}}(d, s, t)),$$

$$(12) \quad X^{\text{III}}(s, z, t) = (\varphi^{\text{III}}(s, z, t), \psi^{\text{III}}(s, z, t), u(s, z, t)),$$

where

$$(13) \quad u(s, z, t) = \frac{1}{L} \bar{u}(s, t) z, \quad 0 \leq z \leq L, \quad \bar{u}(s, t) = L + h(0, s, t),$$

What happens when $m = 0$?

When $m = 0$, there is no groove root. The grain boundary traverses the entire thickness of the thin sample and remains perpendicular to the exterior surface, and **our problem reduces a 2D problem.**

If $\Gamma_t(x) = \{(\tilde{x}(t) + x, \xi(x, t)) | 0 < x < \infty, 0 < t < \infty\}$ is a smooth curve in the xy -plane and $\xi(x, t) = \xi(x - Vt)$ is a **traveling wave solution**, then ξ satisfies

$$(14) \quad V\xi_x = -\frac{\xi_{xx}}{2(1 + \xi_x^2)}, \quad 0 < x < \infty, \quad V := \tilde{x}_t.$$

Solving (14),

$$(15) \quad \xi(x) = \mp 1 \pm \frac{2}{\pi} \arcsin(e^{-\frac{\pi}{2}x}), \quad V = \frac{\pi}{4}.$$

Asymptotic analysis

For the asymptotic analysis we assume that Q is large relative to L in the following sense

$$(16) \quad \frac{L}{Q} = m^{1/3}.$$

We make asymptotic expansions in $m^{2/3}$ for all of the functions, namely

$$(17) \quad \xi = \xi_0 + m^{2/3}\xi_1 + m^{4/3}\xi_2 + \mathcal{O}(m^2),$$

$$(18) \quad D = D_0 + m^{2/3}D_1 + m^{4/3}D_2 + \mathcal{O}(m^2),$$

$$(19) \quad \bar{u} = \bar{u}_0 + m^{2/3}\bar{u}_1 + m^{4/3}\bar{u}_2 + \mathcal{O}(m^2),$$

$$(20) \quad h^j = h_0^j + m^{2/3}h_1^j + m^{4/3}h_2^j + \mathcal{O}(m^2), \quad j = \text{I, II}.$$

Rationale for this choice

Let

$$(21) \quad a = \frac{L}{Q},$$

and let us assume that all of the unknown functions, ξ , D , \bar{u} and h^j , $j = \text{I, II}$, can be expressed as

$$(22) \quad \xi = \xi_0 + b\xi_1 + b^2\xi_2 + \mathcal{O}(b^3),$$

$$(23) \quad D = D_0 + bD_1 + b^2D_2 + \mathcal{O}(b^3),$$

$$(24) \quad \bar{u} = \bar{u}_0 + b\bar{u}_1 + b^2\bar{u}_2 + \mathcal{O}(b^3),$$

$$(25) \quad h^j = h_0^j + bh_1^j + b^2h_2^j + \mathcal{O}(b^3), \quad j = \text{I, II},$$

where a and b are assumed to be $a, b = o(1)$ with respect to m .

Implications of Young's law

Substituting the series into the Young's law, the third coordinate yields that

$$(26) \quad -abh_{1d}^I + abh_{1d}^{II} + \mathcal{O}(ab^2) = -m.$$

Hence, it is reasonable to assume that

$$(27) \quad ab = m.$$

From the first coordinate of Young's law, dominant balance implies

$$(28) \quad a^2b^2 = m\frac{b^2}{a}.$$

From (27) and (28), we get $a = m^{1/3}$, and $b = m^{2/3}$. Thus, we set

$\frac{L}{Q} = m^{1/3}$, and all unknown functions are to be expanded in $m^{2/3}$.

Finding D_1, D_2, ξ_1, V_1

After some work, we get that

$$D_1 \equiv 0, \quad D_2(s, u, t) = -\frac{1}{4} \left[h_{1d}^I(0, s, t) + h_{1d}^{II}(0, s, t) \right] (u^2 - 1);$$

namely, the grain boundary has a parabolic profile. Moreover,

$$\xi_{1t} = \left[\frac{\xi_{1x}}{2(1 + \xi_{0x}^2)} \right]_x + V_0 \xi_{1x} + \xi_{0x} \bar{\xi}_{1t} + G(h_1^I, h_1^{II}) - \xi_{0x} \int_0^\infty G(h_1^I, h_1^{II}) dx,$$

with

$$G(h_1^I, h_1^{II}) = \frac{1}{4} \left[h_{1d}^I(0, s, t) + h_{1d}^{II}(0, s, t) \right] \sqrt{1 + \xi_{0x}^2},$$

and

$$V_1 = - \int_0^\infty G(h_1^I, h_1^{II}) dx.$$

What is A_{eff} ?

Consider the projection of the U-shaped grain on the xy -plane, as in experiment. Looking down from above, the U-shaped grain moves with dimensional velocity $V^*(t)$, where $V^*(t)$ is the horizontal component of the velocity at the “nose.”

Assuming there exists a constant A_{eff} such that

$$(29) \quad V^*(t) = A_{eff} \kappa_{nose}^*,$$

where κ_{nose}^* is the projection of mean curvature at the “nose” of the surface X^I on the xy -plane, and substituting $\kappa^{*III} = \frac{1}{Q} \kappa^{III}$ and $\mathbf{V}^{*III} = \frac{A}{Q} \mathbf{V}^{III}$ into (29), we get that

$$(30) \quad \frac{A_{eff}}{A} = \frac{V(t)}{\kappa_{nose}},$$

where $V(t) = \frac{\pi}{4} + m^{2/3} V_1(t) + \mathcal{O}(m^{4/3})$.

The ratio between A and $A_{eff} \dots$

At the “nose,” we can calculate the projection of κ on the xy -plane up to $\mathcal{O}(m^{4/3})$ accuracy as

$$(31) \quad \kappa = - \frac{\xi_{0_{xx}} + m^{2/3} \xi_{1_{xx}} + \mathcal{O}(m^{4/3})}{2 \left[1 + (\xi_{0_x} + m^{2/3} \xi_{1_x} + \mathcal{O}(m^{4/3}))^2 \right]^{3/2}},$$

yielding that

$$(32) \quad \kappa_{nose} = \frac{\pi}{4} - \frac{m^{2/3}}{2} \left[\frac{\xi_{1_x}}{(1 + \xi_{0_x}^2)^{3/2}} \right]_{x|_{x=0}} + \mathcal{O}(m^{4/3}).$$

Hence, substituting (32) and the expression for $V(t)$ into (30), we get

$$\frac{A_{eff}}{A} = 1 - m^{2/3} \frac{2}{\pi} \left\{ 2 \int_0^\infty G(h_1^I, h_1^{II}) dx - \left[\frac{\xi_{1_x}}{(1 + \xi_{0_x}^2)^{3/2}} \right]_{x|_{x=0}} \right\} + \mathcal{O}(m^{4/3}).$$

References

- [1] A. Rotman, *M.Sc. Thesis, Technion-IIT, Haifa, Israel, 2009.*
- [2] L. Bronsard and F. Reitich, *On Three-Phase Boundary Motion and the Singular Limit of a Vector-Valued Ginzburg-Landau Equation*, Arch. Rational Mech. Anal., vol. **124**, pp. 355-379, (1993)
- [3] C. Herring, *Surface Tension as a Motivation for Sintering*, pp. 143-179 in *The Physics of Powder Metallurgy*. Edited by W. E. Kingston. McGraw-Hill, New York, 1951.
- [4] M.S. Masteller and C.L. Bauer, *Recrystallization of metallic materials*, ed. F. Haessner. Riederer Verlag, Stuttgart, 1978.
- [5] W.W. Mullins, *Capillarity-Induced Surface Morphologies*, Inter. Science **9**, 9–20 (2001).
- [6] W.W. Mullins, *Theory of thermal grooving*, J. Appl. Phys. **28**, 333 (1957).
- [7] D.M. Saylor, D.E. Maso, and G.S. Rohrer, *Experimental Method for Determining Surface Energy Anisotropy and Its Application to Magnesia*, J. Am. Ceram. Soc., **83**, [5], 1226–1232 (2000).
- [8] D. Turnbull, Trans. Am. Inst. Min. Engrs. **191**, 661 (1951).
- [9] J.Ch. Verhasselt, G. Gottstein, D.A. Molodov, and L.S. Shvindlerman, *Shape of moving grain boundaries in Al-bicrystals*, Acta Mater. **47**, [3], 887–892 (1999).

Surface evolution and grain boundary migration in a system of 5 grains

Vadim Derkach¹, M. Sc.

Amy Novick-Cohen¹ Arcady Vilenkin²

¹Department of Mathematics, Technion–IIT, Haifa, Israel

²Department of Physics, Hebrew University, Jerusalem, Israel

(Polycrystalline) Thin Films

Thin films refer to thin material layers ranging in thickness from a fraction of nanometer to several microns. Typically solid thin films are polycrystalline. They are highly important in many technological applications.

Some applications

- Electronic semiconductors, microchips, computer memory.
- Optical coatings (household mirrors, two-way mirrors, silvering).
- Solar photovoltaic systems.
- Thin film drug delivery (thin films that dissolve in liquid).
- Thin film batteries (can be deposited directly onto chips with arbitrary shape or size).

Features of interest

Various physical phenomena connected to grain boundary migration influence thin film stability and robustness.

- Thermal grooving.
- Pitting at quadruple junctions.
- Jerky motion.

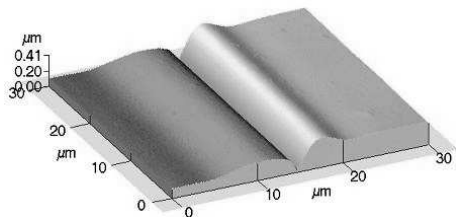

(a)

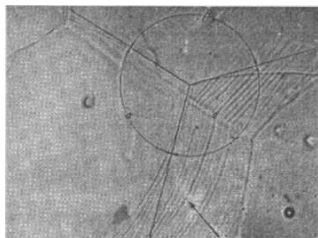

(b)

Figure 1: (a) Grooving. (b) Jerky motion.

A Special 5 and 3 Grain Geometry

We focus on grain boundary migration in an idealized system of 5 grains, see Fig.2(a). Since even the system with 5 grains in the special geometry is difficult to study in full generality, we make symmetry assumptions which reduce our problem to a system of 3 grains, see Fig.2(b)

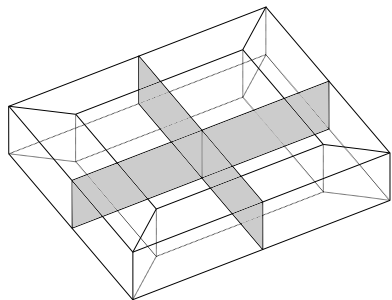

(a)

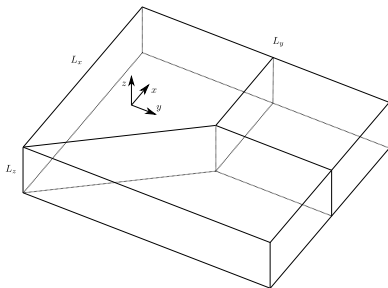

(b)

Figure 2: Sketch of 5 grain and 3 grain geometries.

The Problem Formulation

We neglect elasticity, anisotropy, evaporation/condensation, defects. We focus on the coupled motion of grain boundaries with external surfaces.

Basic assumptions

- Grain boundaries evolve by motion by mean curvature.
- Exterior surfaces evolve by surface diffusion.
- Conditions along thermal grooves:
 - A persistence condition.
 - Balance of mechanical forces.
 - Continuity of the chemical potential.
 - Balance of mass flux.
- Conditions along internal triple junction lines and at corner points...
- Symmetry of the system with respect to the bounding planes and to the mid-plane of the specimen.

Equations of Evolution

We define

- V_n - the normal velocity of an evolving surface.
- H - the mean curvature of an evolving surface.

Motion by mean curvature (for grain boundaries)

$$V_n = \mathcal{A} H. \quad (1)$$

Here

- \mathcal{A} - the reduced mobility of the grain boundary surface.

Motion by surface diffusion (for exterior surfaces)

$$V_n = -\mathcal{B} \Delta_s H. \quad (2)$$

Here

- Δ_s - the surface Laplace - Beltrami operator (the surface Laplacian).
- \mathcal{B} - the surface diffusion coefficient.

Parametric Representations of the Evolving Surfaces

Let $X(\alpha, \beta, t) = (x(\alpha, \beta, t), y(\alpha, \beta, t), z(\alpha, \beta, t))$ be a parametric representation of an evolving 2D surface in 3D, where $0 \leq \alpha, \beta \leq 1$.

- The unit normal \vec{n} to X may be expressed as: $\vec{n} = \frac{\mathbf{X}_\alpha \times \mathbf{X}_\beta}{\|\mathbf{X}_\alpha \times \mathbf{X}_\beta\|}$.
- The normal velocity V_n of X can be written as: $V_n = \langle \mathbf{X}_t, \vec{n} \rangle$.
- The mean curvature of X is given by

$$H = \frac{\langle \langle \mathbf{X}_\beta, \mathbf{X}_\beta \rangle \mathbf{X}_{\alpha\alpha} - 2 \langle \mathbf{X}_\alpha, \mathbf{X}_\beta \rangle \mathbf{X}_{\alpha\beta} + \langle \mathbf{X}_\alpha, \mathbf{X}_\alpha \rangle \mathbf{X}_{\beta\beta}, \vec{n} \rangle}{2g}$$

where $g = \langle \mathbf{X}_\alpha, \mathbf{X}_\alpha \rangle \langle \mathbf{X}_\beta, \mathbf{X}_\beta \rangle - \langle \mathbf{X}_\alpha, \mathbf{X}_\beta \rangle^2$,

- ...

Instead of specifying tangential velocities, we impose uniform grid spacing $\|\mathbf{X}_\alpha\|_\alpha = 0$, $\|\mathbf{X}_\beta\|_\beta = 0$, which may be written as

$$\langle \mathbf{X}_\alpha, \mathbf{X}_{\alpha\alpha} \rangle = 0, \quad \langle \mathbf{X}_\beta, \mathbf{X}_{\beta\beta} \rangle = 0. \quad (3)$$

which improves numerical performance (Pan & Wetton, 2008).

Conditions at the Quadruple Junction

Assumptions:

- Local limiting regularity at the quadruple junction: in a limiting neighborhood of the quadruple junction, triple junction lines are straight.
- Young's law holds along all triple junction lines, up to the quadruple junction.

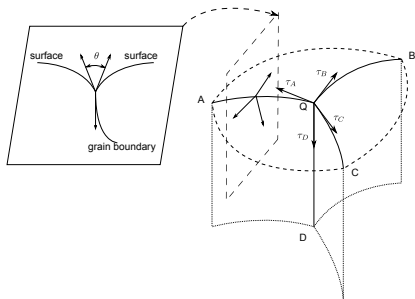

Figure 3: Sketch of a quadruple junction.

A Tetrahedron Construction and Balance Angles at the Quadruple Point

Geometric considerations imply that

$$0 \leq \varphi \leq \frac{2\pi}{3}, \quad \frac{\pi}{2} \leq \psi \leq \pi, \quad (4)$$

that the angles φ , ψ are given by

$$\cos(\varphi) = -\frac{2 - m^2}{4 - m^2}, \quad (5)$$

$$\cos(\psi) = -\frac{1}{\sqrt{3}} \frac{m}{\sqrt{4 - m^2}}, \quad (6)$$

and m must satisfy $m \in [0, \sqrt{3}] \subset [0, 2]$.

Building a tetrahedron based on the vectors τ_A , τ_B and τ_C yields the following construction:

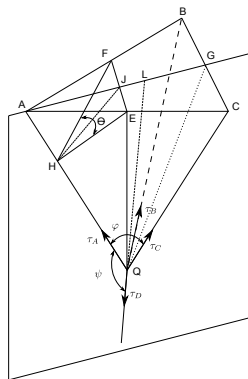

Figure 4: A tetrahedron construction at the quadruple junction.

Discretization of the PDAE System and Boundary Conditions

Finite difference methods and a staggered grid are used to discretize the governing equations and boundary conditions:

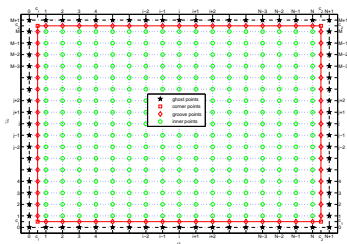
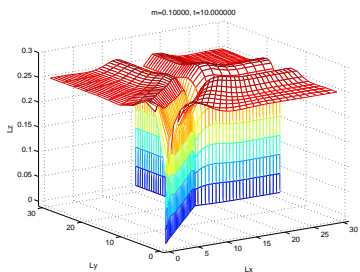

Figure 5: Sketch of mesh grid.

We set $\beta_j = (j - 1/2) h_\beta$, $\alpha_i = (i - 1/2) h_\alpha$, $j = 1, \dots, M$, $i = 1, \dots, N$, where h_α , h_β denote staggered grid spacings, and $N = \frac{1}{h_\alpha}$, $M = \frac{1}{h_\beta}$.

We let $X_{i,j}^k = X(\alpha_i, \beta_j, t_k)$ denote the approximation of evolving surface X at the staggered grid point (i, j) at time $t_k \geq 0$.

Thermal Grooving for $m = 0.1$



(a)

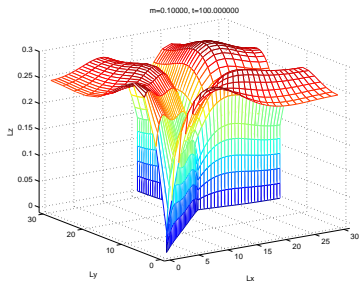

(b)

Figure 6: Results for $m = 0.1$ at times (a) $t = 10$, (b) $t = 100$.

Corner points

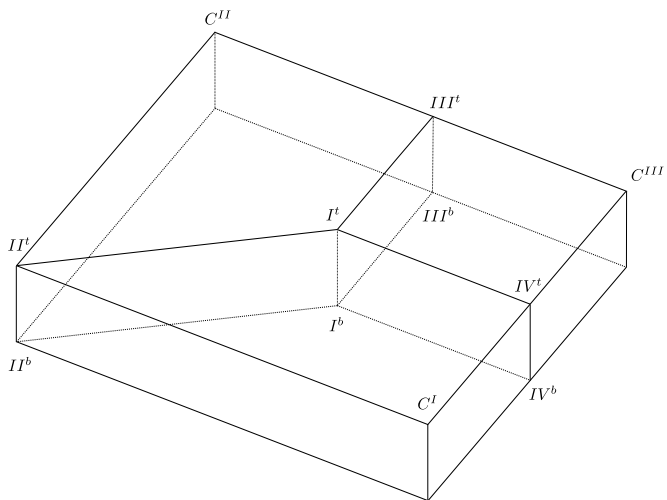
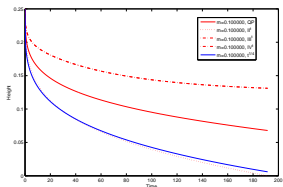
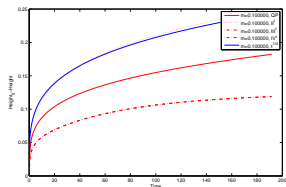

Figure 7: Corner points.

The Height of Thermal Grooving at the Corner Points



(a)





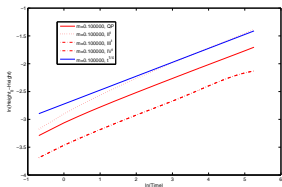



(b)







(c)

Figure 8: The height of the corner points as a function of time, for the parameter $m = 0.1$.

References I

-  A.Vilenkin and A.Novick–Cohen. **Grain boundary migration in thin films: the effects of grain grooves in nano films.** *AES–ATEMA' 2007 International Conference*, pages 127-134, August 6–10, 2007.
-  W.W.Mullins. **Theory of thermal grooving.** *J.Appl.Phys.*, **28**:333-339, 1957.
-  J.Nocedal and S.J.Wright. **Numerical Optimization.** Springer Series in Operation Research. New York : Springer Science + Business Media, Inc., 1999.
-  Z.Pan and B.Wetton. **Numerical Methods for Coupled Surface and Grain Boundary Motion.** *European Journal of Applied Mathematics*, **19**:311-327, 2008.
-  G.Gottstein and L.S.Shvindlerman. **Grain boundary migration in metals: thermodynamics, kinetics, applications.** CRC Press, 2nd edition, 2010.
-  U.M.Asher and L.R.Petzold. **Computer Methods for Ordinary Differential Equations and Differential - Algebraic Equations.** Philadelphia: Society for Industrial and Applied Mathematics, 1998.

References II

-  F.Y.Genin, W.W.Mullins and P.Wynblatt. **Capillary instabilities in thin films: A model of thermal pitting at grain boundary vertices.** *Acta. Metall. Mater.*, **40**:3239-3248, 1992.
-  A.Averbuch, M.Israeli and I.Ravve, **Electromigration of intergranular voids in metal films for microelectronic interconnects.** *Computational Physics*, **189**:481-502, 2003.
-  C.S.Smith. **Grains, Phases, and Interfaces: An Interpretation of Microstructure.** *Trans. AIME*, **175**:15-51, 1948.
-  D.J.Srolovitz and S.A.Safran. **Capillarity instabilities in thin film.** *Appl. Phys.*, **60**:247-254, 1986.

Thank you for your interest!